

WATER HEATER THERMAL EXPANSION TANKS

Owner's Manual

Models: 2 - 5 Gallon Capacity

- Safety Instructions
- Installation
- Maintenance
- Warranty



Certified to NSF/ANSI 61



	⚠ WARNING
	<p>Read and understand manual and safety messages before installing, operating or servicing this water heater.</p> <p>Failure to follow instructions and safety messages could result in death or serious injury.</p>

Thank You for purchasing this Thermal Expansion Tank. Properly installed and maintained, it should give you years of trouble free service.





KEEP THIS MANUAL FOR FUTURE REFERENCE WHENEVER MAINTENANCE ADJUSTMENT OR SERVICE IS REQUIRED.

SAFE INSTALLATION USE AND SERVICE

Your safety and the safety of others is extremely important in the installation, use and servicing of this expansion tank.

Many safety-related messages and instructions have been provided in this manual and on your own expansion tank to warn you and others of a potential injury hazard. Read and obey all safety messages and instructions throughout this manual. It is very important that the meaning of each safety message is understood by you and others who install, use or service this expansion tank.

All safety messages will generally tell you about the type of hazard, what can happen if you do not follow the safety message and how to avoid the risk of injury.

	This is the safety alert symbol. It is used to alert you to potential personal injury hazards. Obey all safety messages that follow this symbol to avoid possible injury or death.
	DANGER indicates an imminently hazardous situation which, if not avoided, will result in injury or death.
	WARNING indicates a potentially hazardous situation which, if not avoided, could result in injury or death.
	CAUTION indicates a potentially hazardous situation which, if not avoided, could result in minor or moderate injury.
	CAUTION used without the safety alert symbol indicates a potentially hazardous situation which, if not avoided, could result in property damage.

PROFESSIONAL INSTALLATION, COMMISSIONING, SERVICE AND MAINTENANCE REQUIRED

GENERAL SAFETY



WARNING

Read and understand manual and safety messages before installing, operating or servicing this water heater.

Failure to follow instructions and safety messages could result in death or serious injury.

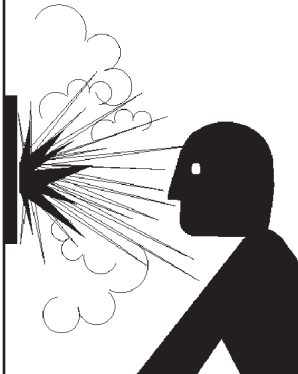

WARNING

Explosion Hazard

- Temperature-pressure relief valve must comply with ANSI Z21.22 and ASME code.
- Overheated water can cause water tank explosion.
- Properly sized temperature and pressure relief valve must be installed in opening provided.
- Failure to follow these instructions could result in death or serious injury.

CAUTION

Improper installation and use may be hazardous and can result in property damage.

- Improper installation and/or pressure settings will void warranty.
- Install in accordance with local codes.

Refer to manual for instruction and service.

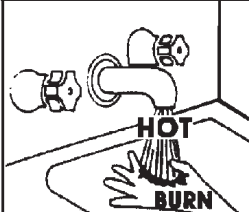

DANGER

- Burn hazard.
- Hot water discharge.
- Keep hands clear of drain valve discharge.

TABLE OF CONTENTS

SAFE INSTALLATION USE AND SERVICE.....	2	LOCATING THE NEW EXPANSION TANK.....	5
GENERAL SAFETY.....	2	INSTALLING THE EXPANSION TANK.....	5
TABLE OF CONTENTS.....	3	MAINTENANCE.....	6
SPECIFICATIONS.....	3	WARRANTY.....	7
IMPORTANT INSTRUCTIONS BEFORE INSTALLATION.....	4		

SPECIFICATIONS

EXPANSION TANKS FOR HOT WATER HEATERS

Many local codes require back flow preventers. Since this seals off the system an expansion tank is required or the relief valve will discharge on every heating cycle. Thermal expansion tanks eliminate this wasteful, costly and dangerous practice. The thermal expansion tank is certified to NSF/ANSI-61 DHOT (140° F) and pressures to 150 PSI. **DO NOT USE A STANDARD TANK.** The sizing chart will allow you to choose the correct size expansion tank for your application.

PURPOSE OF EXPANSION TANKS

When water is heated it expands. Provision must be made for this expansion in a closed hot water system. This precharged diaphragm tank stores the expanded hot water then returns water to the system when the temperature drops.

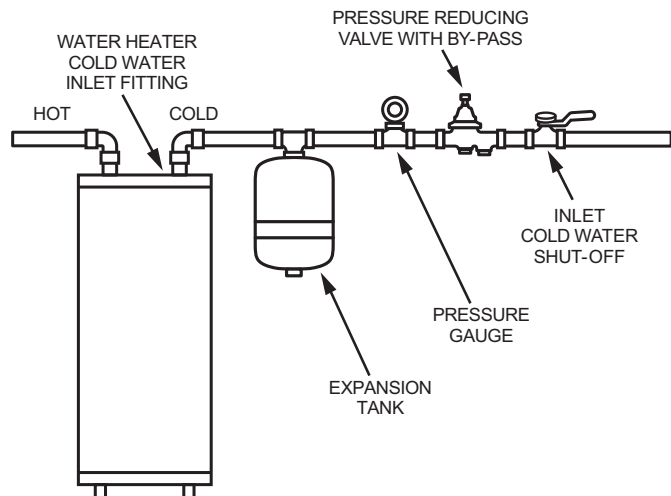

RECOMMENDED INSTALLATION - VERTICAL MOUNTING

TANK SPECIFICATIONS

	2 Gallon	5 Gallon
CAPACITY IN GALLONS	2.1	4.8
PRECHARGE PRESSURE IN PSI	38	38
DIMENSIONS "A"	11.0"	13.7"
DIMENSIONS "C"	7.9"	10.6"
DISCHARGE CONNECTION "E"	3/4" NPT	3/4" NPT
WEIGHT	4.5 LBS.	8.2 LBS.

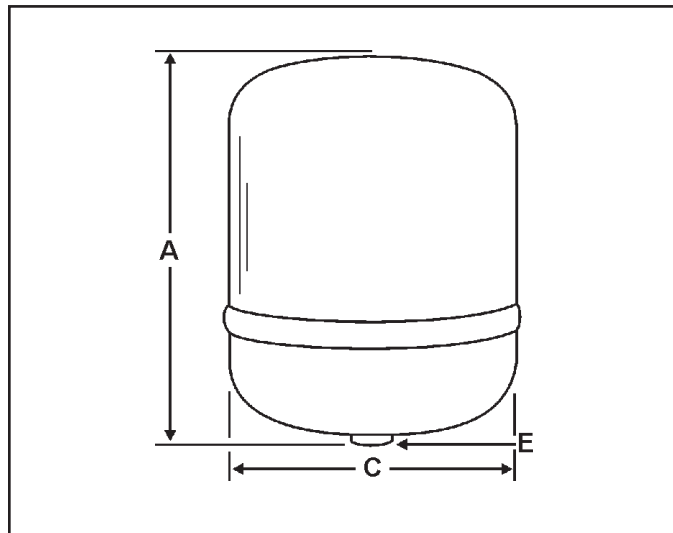

EXPANSION TANK SIZING CHART

Assumed 140° Max. Temp and 150 PSI Max. Pressure.

EXPANSION TANK NEEDED

INCOMING WATER PRESSURE	WATER HEATER CAPACITY (GALLONS)						
	30	40	50	66	80	100	120
40 psi	2 GAL	2 GAL	2 GAL	2 GAL	5 GAL	5 GAL	5 GAL
50 psi	2 GAL	2 GAL	2 GAL	2 GAL	5 GAL	5 GAL	5 GAL
60 psi	2 GAL	2 GAL	2 GAL	5 GAL	5 GAL	5 GAL	5 GAL
70 psi*	2 GAL	2 GAL	2 GAL	5 GAL	5 GAL	5 GAL	5 GAL
80 psi*	2 GAL	2 GAL	2 GAL	5 GAL	5 GAL	5 GAL	5 GAL

* Use a pressure reducing valve for regulating inlet pressure at 60 psi

IMPORTANT INSTRUCTIONS BEFORE INSTALLATION

BEFORE INSTALLATION

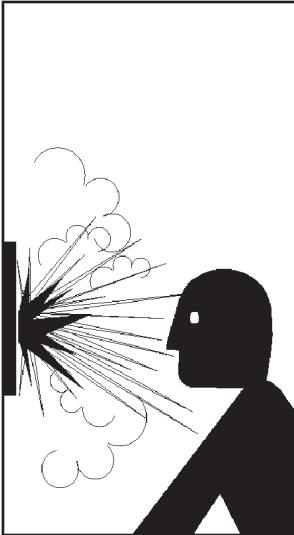

⚠ WARNING
Explosion Hazard
<ul style="list-style-type: none">• Temperature-pressure relief valve must comply with ANSI Z21.22 and ASME code.• Overheated water can cause water tank explosion.• Properly sized temperature and pressure relief valve must be installed in opening provided.• Failure to follow these instructions could result in death or serious injury.

1. Be sure installation meets all local plumbing codes.
2. If you are not thoroughly familiar with plumbing and safety practices, consult your local store for further information.
3. Read all information and instructions pertaining to the temperature - pressure relief valve in the water heater's manual. The temperature - pressure relief valve must be checked for proper operation and replaced if it is faulty according to the water heater's manual.
4. Read this owner's manual and the installation rules carefully. If you do not follow the safety rules, the expansion tank will not operate properly. It could cause DEATH, SERIOUS BODILY INJURY AND/OR PROPERTY DAMAGE.
5. If incoming water pressure to the home exceeds 80 psi, a pressure reducing valve will be required. Recommended inlet water pressure is 60 psi or less.

6. In order to determine incoming water pressure and for proper adjustment of the pressure reducing valve, a pressure gauge must be installed between the pressure reducing valve and expansion tank.
7. The complete piping system, including expansion tank and pressure reducing valve, MUST be protected against below freezing temperatures. Failure to do so could cause severe water damage.
8. To safeguard against a possible dangerous malfunction of the expansion tank, review the installation instructions before putting the water supply system back into operation.

This hydro-pneumatic tank is designed and intended for hot or cold water storage at a maximum pressure of 150 per square inch gauge (150 PSIG). Expansion tank should be installed in the incoming cold water line. Any use other than water or at a sustained or instantaneous pressure in excess of 150 PSIG is UNSAFE. A pressure relief valve of adequate size must be incorporated in the water heater system. **This expansion tank, as all tanks, will eventually leak. Do not install without adequate drainage provisions where water leakage will cause damage.** Failure to follow these instructions can cause an explosion and result in SERIOUS OR FATAL INJURY. The manufacturer of this tank does not accept any liability or other responsibility for personal injury or property damage resulting from improper use, installation, or operation of this tank, or of the system of which it is a part.

CAUTION

Improper installation and use may be hazardous and can result in property damage.

- Improper installation and/or pressure settings will void warranty.
- Install in accordance with local codes.

Refer to manual for instruction and service.

LOCATING THE NEW EXPANSION TANK

FACTS TO CONSIDER ABOUT THE LOCATION

! CAUTION

Install Expansion Tank on Cold Water Side ONLY!

- Installing the expansion tank on the hot water side can lead to premature failure of the tank and/or components. This can cause system damage and/or water damage.

1. The location selected should be indoors in an area not subject to freezing.
2. The items which should be installed in sequence in the cold water line are (1) the EXPANSION TANK must be installed at least 18 inches away from the cold water inlet fitting on the water heater, (2) the PRESSURE GAUGE, and (3) the PRESSURE REDUCING VALVE, if required, see Figure 1.
3. The expansion tank is designed to be in a vertical position. If it must be installed horizontally, support for the expansion tank must be provided.
4. The expansion tank, pipes and your connections may, in time leak. The expansion tank should be located in an area where water leakage from the tank or connections will not result in

damage to the area around the expansion tank or to the lower floors of the structure.

5. Ensure that access to the installation area is restricted. Do not install where children are present or may be present.

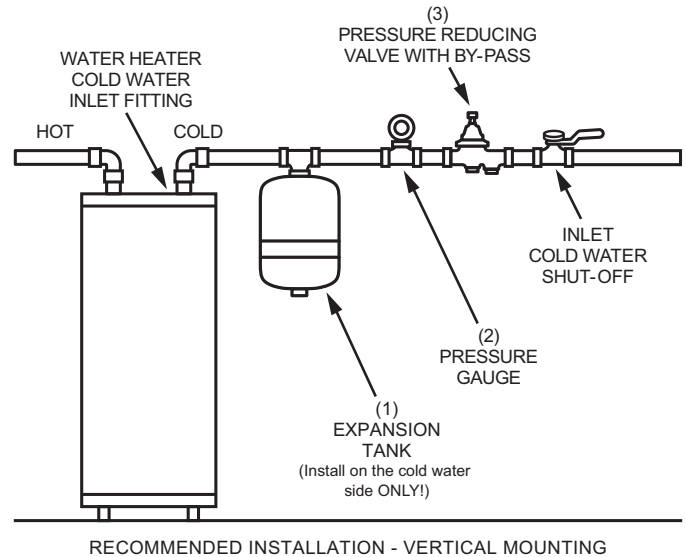

FIGURE 1.

INSTALLING THE EXPANSION TANK

WATER PIPING

This expansion tank is designed for operation on the inlet cold water line and is limited to a maximum working pressure of 150 pounds per square inch (psi) is rated to NSF/ANSI-61 DHOT (140° F). The continuous temperature on the tank cannot exceed 140° F.

Figure 1 above shows the correct valves and fittings that you will need to install your expansion tank. A threaded (3/4") water connection is supplied on the tank bottom.

FOLLOW THE INSTALLATION INSTRUCTIONS FOUND IN THE PACKAGING OF THE PRESSURE REDUCING VALVE AND PRESSURE GAUGE.

1. The water supply and power (electricity or gas) must be shut off during the installation of the valves and expansion tank. Follow the instructions found on the water heater and in the owner's manual.
2. Install expansion tank, pressure gauge and pressure reducing valve, if required, as shown above in Figure 1.
3. After installing the expansion tank and valves it will be necessary to expel all air from the piping. Turn the cold water inlet shut-off valve "ON". To purge the air, open a faucet and wait until a steady stream of water is coming from the faucet. At this time, close the faucet.

ADJUSTING WATER PRESSURE

1. Recommended inlet water pressure is 60 psi or less.
2. Increase or decrease the pressure by following the installation

instructions found in the packaging of the pressure reducing valve and pressure gauge.

3. Open a nearby faucet allowing water to run briefly and then close the faucet. Check pressure gauge again and made additional screw adjustments as necessary. It may be necessary to repeat this procedure several times before the pressure can be adjusted to 60 psi or less.

CHECKING EXPANSION TANK AIR CHARGE

1. Shut off main cold water supply valve.
2. Open a nearby faucet allowing water to run until it stops. This indicates the pressure has been relieved.
3. Using a tire gauge, check the expansion tank's pre-charge pressure (38 psi). **THE EXPANSION TANK AIR CHARGE MUST BE ADJUSTED TO MATCH THE INCOMING WATER PRESSURE.** If the air charge pressure needs to be adjusted upward, use only a manual type tire pump to increase the pressure. If the air charge needs to be reduced, depress the valve core to release pressure.
4. It is important that you read your city system pressure correctly. If you read it when it is already hot and expanded you will get false readings. If you have a pressure gauge in your line, you should open one hot water valve and let the water run for 15 minutes to reduce the line pressure, then shut the valve off and then read the pressure immediately. If you don't have a pressure gauge in your

line you can either call your local water department or you can get a close approximation from your Expansion Tank. If you follow the above procedure with your tank installed and read the air pressure from your tank you will have an approximate system pressure. (In this case read the pressure with the tank full of water). If the air pressure reads 50 PSI you need to shut-off your main water line, open a valve let the water out of the tank, and fill the tank with 50 PSI of air pressure.

5. Open the cold water supply valve.
6. Now the water heater can be put back into operation. Follow instructions found on the water heater and in the manual.
7. Failure to properly size the expansion tank and to properly adjust the pre-charge will shorten the life expectancy of the product, can void the product warranty, and can lead to premature failure.

MAINTENANCE

TANK MAINTENANCE

Unless otherwise stated, at least once every 6 months, the expansion tank must be checked to verify that the pre-charge is within the value indicated on the label (factory pre-charge or customer set pre-charge). Always check the pre-charge when the tank is isolated and empty of water.

- Inspect the tank visually for signs of damage / corrosion at least once every 6 months
- To lengthen the life of the expansion tanks external protection, periodically clean the external portions of the tank using warm soap and water
- To ensure the proper functioning of the system, the expansion tank must be replaced in the event of excessive deterioration

WARRANTY

ONE OR FIVE YEAR LIMITED WARRANTY ON 2 AND 5 GALLON CAPACITY THERMAL EXPANSION TANKS

(See last digit of model number to determine if the tank is one year or five year.)

Hereafter "The Company" warrants this expansion tank in case of a leak within one (1) or five (5) years depending on the model purchased from the date of purchase or in the absence of a Bill of Sale verifying said date, from the date indicated on the model and rating plate affixed to this tank. In case of a defect, malfunction, or failure to conform to this warranty, the Company will repair or replace this tank. No labor, installation, or freight (if any) charges are included in this warranty. You must pay these costs.

Prior to return of the expansion tank or part to the manufacturer for inspection, the Company will, if requested, ship a replacement expansion tank or part C.O.D. and later provide such reimbursement as subsequent inspection indicates is due under these warranties.

EXCLUSIONS AND LIMITATIONS OF THESE LIMITED WARRANTIES

1. The limited warranties provided herein are in lieu of any and all warranties, expressed or implied, including, but not limited to, implied warranties of merchantability and fitness for a particular purpose; provided, however, that implied warranties are not disclaimed during the one-year period from date of purchase. Some states do not allow limitations on how long an implied warranty lasts, so the above limitation may not apply to you.
2. The company shall have no liability hereunder, either direct or contingent, for incidental or consequential damages. Some states do not allow the exclusion or limitation of incidental or consequential damages, so the above limitation or exclusion may not apply to you.
3. This warranty gives you specific legal rights, and you may also have other rights which vary from state to state.
4. These warranties shall be void and shall have no effect:
 - a. If the design or structure of the tank is, or is attempted to be, modified or altered in any way, including, but not limited to, by attaching non-Company approved appliances or equipment.
 - b. If the tank is not properly installed in accordance with all local ordinances and regulations pertinent to tanks and the installation and instruction manual provided with this tank.
 - c. If the expansion tank is installed outdoors. This tank is intended for indoor installation only.
 - d. If leaks in the tank, or defects in other parts, arise as the result of improper use, negligence in operation, accident, or from inability of the tank or any of its parts to function because of repairs, adjustments, or replacements improperly made outside the Company's factory, or because of fire, floods or lightning.
 - e. If the model and rating plate has been defaced or discarded and you do not have a Bill of Sale to verify the purchase date.
 - f. If the tank is used for any purpose other than expansion for potable water heating systems.
 - g. If the tank is used with pools, whirlpools, or hot tubs, or with any equipment or system that uses heavily chlorinated or otherwise nonpotable water.
 - h. If leaks in the tank or defects in other parts occur as a result of the tank being exposed to a highly corrosive atmospheric condition.
 - i. If leaks in the tank or defects in other parts occur as a result of the tank containing and/or being operated with desalinated (de ionized) water.
 - j. If leaks in the tank or defects in other parts arise as a result of sizing that does not comply with the manufacturer's currently published sizing guides or sizing recommended by the manufacturer.
 - k. If this expansion tank or any part has been under water.
5. Replacements and/or repairs furnished under these warranties do not carry a new warranty, only the unexpired portion of the original warranty.
6. The terms of this warranty may not be varied by any person, whether or not purporting to represent or to act on behalf of the Company.
7. In order to obtain service under these warranties you must promptly notify the installing contractor or dealer, giving the nature of the problem and the model and serial number of the tank. If for any reason the installer or dealer cannot be located or fails to provide satisfactory warranty service, you should write the Company with the above information.

